

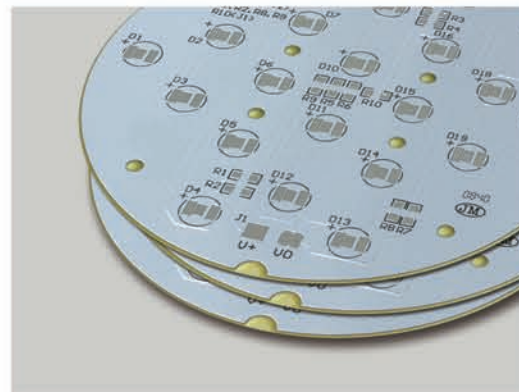

POLYTRONICS
TTC. POLYTRONICS TECHNOLOGY CORP.

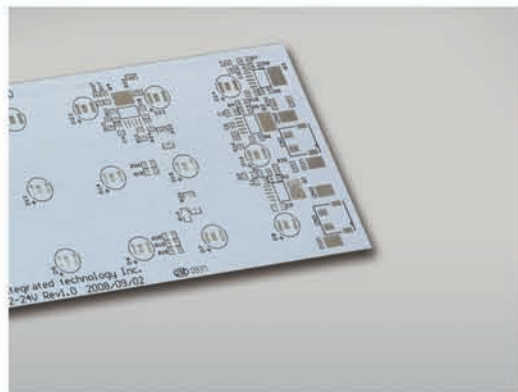

**PRODUCT
CATALOG**

產品型錄

T C B

**Thermal Conductive Board
散熱基板系列產品**

Thermal Management Product

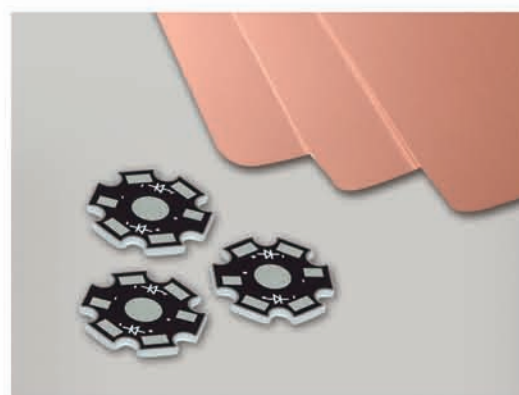
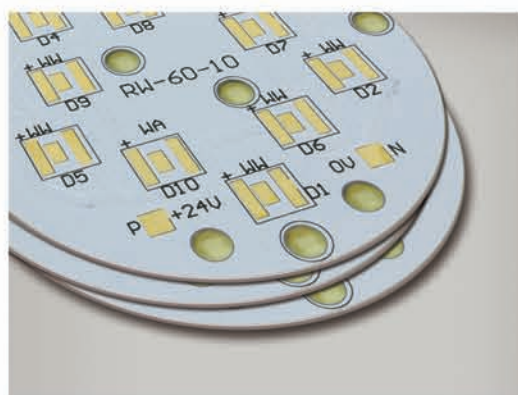

www.atechcircuit.com

RoHS-compliance product with halogen free & lead free process

簡介 / Overview

■ 高導熱基板(TCB) / Thermal Conductive Board

聚鼎科技高導熱基板(TCB) / 絕緣金屬基板(IMS)是一種具有高導熱係數之印刷電路板，可同時提供電子元件所需訊號、電源、熱傳導途徑、可靠度與耐熱特性，其導熱係數為傳統樹脂基板(FR4)的五至二十倍以上，能將電子元件產生之熱能經由基板結構，快速的傳導至後端散熱鰭片或熱管等散熱模組。高導熱基板之架構係由銅箔電路層、導熱絕緣層以及金屬背板所組成，藉由特殊的高分子配方以及導熱填充物的材料技術下，相關產品已通過多項嚴苛的長時間環境測試，並獲得國際認證通過。

聚鼎科技多年來陸續開發出高導熱率之系列產品，在致力於綠色產品的品質政策，以及無溶劑、無鹵素與磷化合物使用的原則下，所有產品均通過RoHS等國際規範之有毒物質檢驗，同時兼顧良好的產品特性與環境保護之全球趨勢。

Thermal Conductive Board (TCB), or Insulated Metal Substrate (IMS), provides the advantages of high thermal conductivity, reliability and solder heat endurance. The TCB substrate is a sandwich structure, which includes layers of conductor, insulator and metal base. Traditionally, this insulator is made of epoxy, epoxy filled glass fiber, polyimide, or other dielectric materials. However, these kinds of insulators could not meet the requirement in high-power electronic devices. The heat generated by these devices will accumulate, and the life time and reliability of the end product will decrease.

Polytronics' TCB product is not only a printed circuit board but also a heat transfer interface. The insulator is made by a unique polymer composite that combines epoxy resin and high thermal conductivity filler, and the thermal conductivity is about 5 to 20 times higher than the traditional epoxy filled glass fiber system.

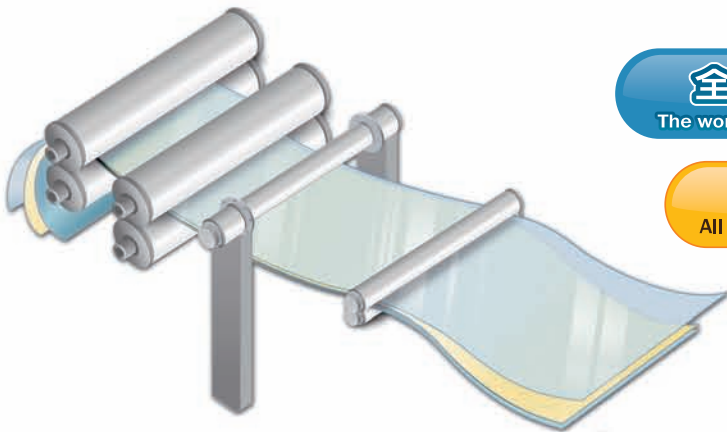

全球唯一捲狀式12W/mK散熱膠片

The world's only thermal conductive prepreg up to 12W/mK in roll package.

全系列UL認證、國際大廠指定選用

All series are UL certified and appointed by international name-brand companies.

無溶劑乾式製程、不爆板綠色且環保

Non-solvent dry process. No de-lamination and green products.

■ 產品應用 / Applications

- 高亮度LED照明/背光模組
High brightness LED lighting/backlight module
- 高功率電子元件(高功率電晶體、整流器)
Power electronics (inverter, transistor, DC/DCconverter, regulator)
- 汽車應用 (整流器、電源模組)
Automotive (regulator, power module)
- 音響設備 (平衡器、擴大機)
Audio (equalizer, amplifier)



Lighting



Backlight



Power Electronics



Automotive



Audio



Solar Cell



Mother Board

■ 產品特色 / Features

- 高導熱特性
Excellent thermal conductivity
- 極佳之環境可靠度
Excellent reliability
- 符合RoHS要求
RoHS compliance
- 極佳之耐漂錫特性
Excellent solder heat endurance
- 極佳之耐漂錫特性
Excellent solder heat endurance
- 符合無鹵素要求
Halogen free

■ UL認證 / UL Certification

- 認證號碼：E312082
File No: E312082
- 通過UL 746E
UL 746E recognized
- 符合UL 94V-0
UL 94V-0 Certified

■ 專利 / Patents

- 美國、台灣及中國地區合計超過15篇專利，其中涵蓋材料、製程與產品應用
Over 15 patents (US, TW, CN) are issued and published covering material, process and product applications.

www.atechcircuit.com

高導熱單面基板 / Insulated Metal Substrate

■ 產品簡介 / Product Description

高導熱單面基板產品(TCB)能夠針對各種銅厚、絕緣層特性、金屬背板規格需求，提供符合客戶要求的高性能的產品。

Polytronics offers various kinds of combination of base metal, copper foil, and dielectric layers to meet the general requirement of single layer thermal conductive printed circuit board.



圖1. 絕緣金屬基板結構圖 / Figure 1. Substrate structure of Insulated Metal Substrate

表1. 產品規格 / Table 1. Standard specification

項目/Item	材質/Material	規格/Specification	備註/Note
基板尺寸/Panel Size		610x510mm	
金屬背板/Base Metal	鋁/Aluminum	1.0, 1.5, 2.0mm	
導熱絕緣層/Dielectric Layer	環氧樹脂/Epoxy resin 陶瓷填充物/Ceramic filler	80, 100, 150 μ m	
銅箔/Cu Foil	電解銅箔/Copper	1 oz	General Circuit
		2 oz	High Current Circuit
		3~6 oz	Ultra High Current Circuit

若有任何特殊規格需求，請與我們聯繫 / If there is any specific inquiry other than the standard specification, please contact us.

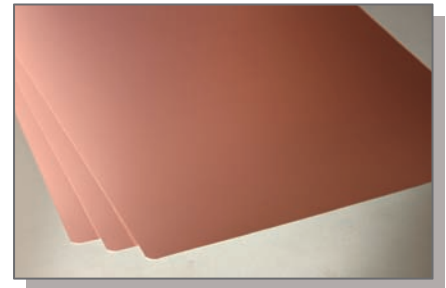
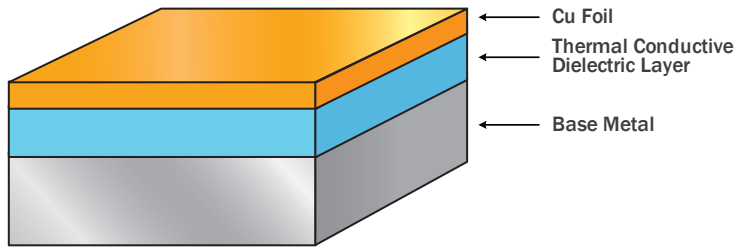
■ 產品料號定義 / Part Number Definition

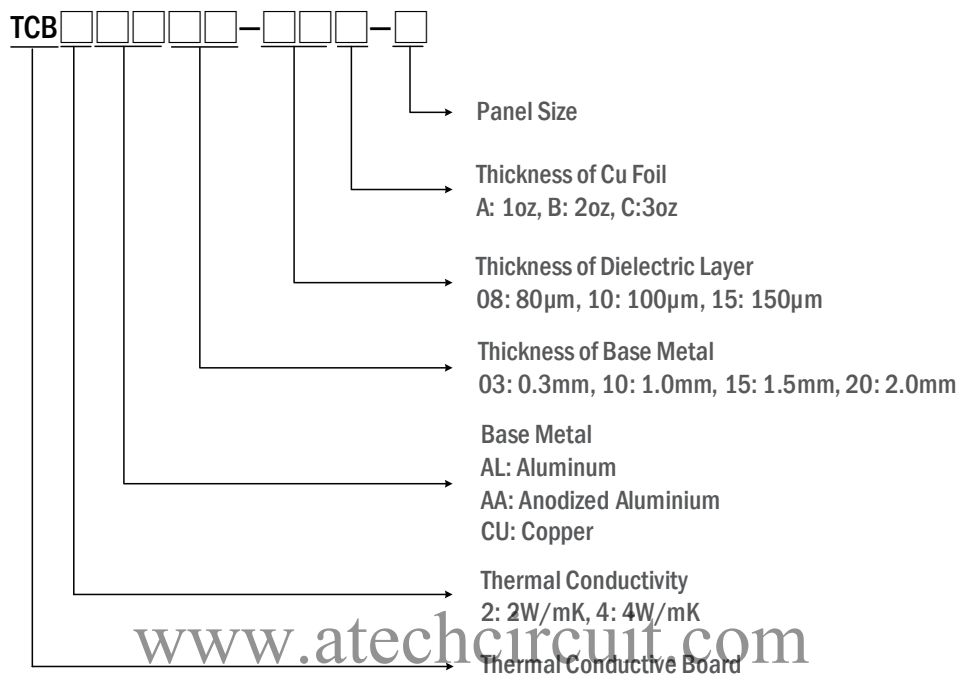

■ 產品特性 / General Properties

表2. 產品特性表/ Table 2. General Properties

項目 Item	測試方法 Test Method	測試條件 Test Condition	產品名稱 (UL型號) Product Name (UL Type Name)				
			TCB-2L	TCB-2 (TCB-2AL)	TCB-4	TCB-8	
導熱率 [W/m-K] Thermal Conductivity [W/m-K]	ASTM D5470	C-96/25/65	2	3	4	8	
崩潰電壓 [AC KV] Typical Break Down Voltage [AC KV]	JIS C 2110	C-96/25/65	5.0	5.0	4.5	4.5	
		E-1000/150					
		Solder Floating, 260°C/30 min					
		150°C ~ -50°C/1000 cycles					
剝離強度 [N/cm] Typical Peeling Strength [N/cm]	JIS C 6481	C-96/25/65	18	18	18	18	
		E-1000/150					
		Solder Floating, 260°C/30 min					
		150°C ~ -50°C/1000 cycles					
吸水率 [%] Water Absorption	IPC-TM-650 2.6.2.1	C-96/25/65	14	14	14	14	
		E-1000/150					
		Solder Floating, 260°C/30 min					
		150°C ~ -50°C/1000 cycles					
介電常數 Dielectric Constant	IPC-TM-650 2.5.5.1	C-96/25/65, 1MHz	4.6	4.8	4.9	5.2	
介電損失 Dielectric Loss Tangent	IPC-TM-650 2.5.5.1	C-96/25/65, 1MHz	0.021	0.021	0.022	0.024	
電容 [μF/m ²] Capacitance	IPC-TM-650 2.5.5.1	C-96/25/65, 1MHz	1.1	1.1	1.2	1.2	
表面電阻 [Ω] Surface Resistance	IPC-TM-650 2.5.17.1	C-96/25/65, 1MHz	>10 ¹⁵	>10 ¹⁵	>10 ¹⁵	Under Evaluation	
體積電阻 [Ω · cm] Volume Resistance	IPC-TM-650 2.5.17.1	C-96/25/65, 1MHz	>10 ¹³	>10 ¹³	>10 ¹⁴	Under Evaluation	
玻璃轉移溫度 (T _g) [°C] Glass Transition Temp.	IPC-TM-650 2.4.25	DSC	130	130	140	140	
耐熱性測試 [minutes] Thermal Resistance	JIS C 6481	Solder Floating, 260°C	>60	>60	>60	>60	
	IPC-TM-650 2.4.24.1	TMA	T260	>60	>60	>60	>60
			T288	>30	>30	>30	>30
裂解溫度 (T _d) [°C] Decomposition Temp.	IPC-TM-650 2.4.24.6	TGA	2%	350	350	350	350
			5%	400	380	400	400
熱膨脹係數 CTE [PPM/°C] Thermal Expansion	IPC-TM-650 2.4.24.5	TMA	>T _g	37	30	25	35
			<T _g	24	20	16	28
熱膨脹係數 CTE [%] Thermal Expansion	IPC-TM-650 2.4.24.5	TMA 50~260°C	0.68	0.54	0.52	0.58	
比較路徑指數 CTI [V] Comparative Tracking Index	UL 746E	C-40/25/50	600	600	600	600	
耐燃性 Flammability	UL 94	C-40/25/50	V-0	V-0	V-0	V-0	

■ 可靠度測試數據 / Reliability Testing Data

測試基板：TCB-2 (鋁板厚度：1.5mm, 絕緣層厚度：100 μ m, 銅箔厚度：35 μ m)

Tested substrate: TCB-2 (aluminum thickness: 1.5mm, thermal conductive dielectric layer thickness: 100 μ m, copper foil thickness: 35 μ m)

(1) 絕緣耐電壓測試/Dielectric Breakdown Voltage

高導熱基板產品在經過漂錫、冷熱衝擊、高溫高濕環境及高溫儲存環境測試後仍然可維持良好的絕緣耐電壓特性。
Polytronics TCB has excellent dielectric breakdown strength even after solder dipping, high temperature, high humidity, long term storage or thermal shock conditions.



圖1. 漂錫測試260°C

Figure 2. Dielectric breakdown voltage after aging test at 260°C

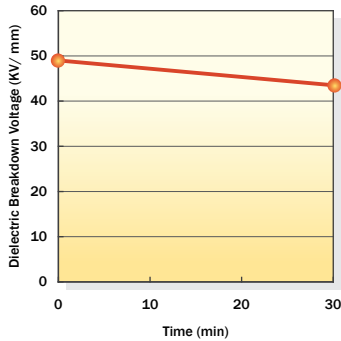

圖2. 高溫儲存環境測試150°C

Figure 3. Dielectric breakdown voltage after aging test at 150°C

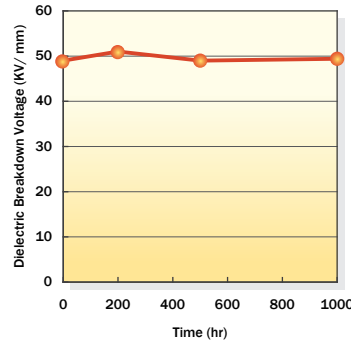

圖3. 冷熱衝擊測試
-50°C/ 30min ~ 150°C/30min

Figure 4. Dielectric breakdown voltage after thermal shock test during -50°C/ 30min ~ 150°C/30min

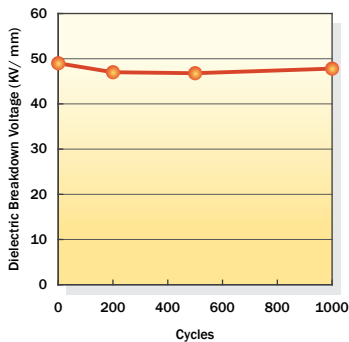

圖4. 高溫高濕環境測試
85°C/ 85%RH

Figure 5. Dielectric breakdown voltage after aging test at 85°C/ 85%RH

(2) 剝離強度測試/Peeling Strength

高導熱基板產品在經過漂錫、冷熱衝擊、高溫高濕環境及高溫儲存環境測試後仍然可維持良好的剝離強度。
Polytronics TCB has excellent peeling strength even after solder dipping, high temperature, high humidity, long term storage or thermal shock conditions.

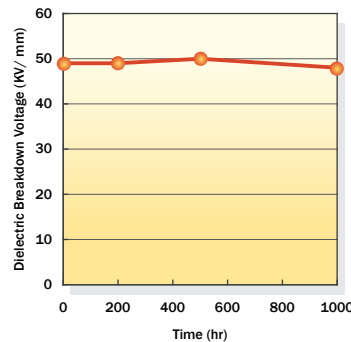

圖5. 漂錫測試260°C

Figure 6. Peeling strength after aging test at 260°C

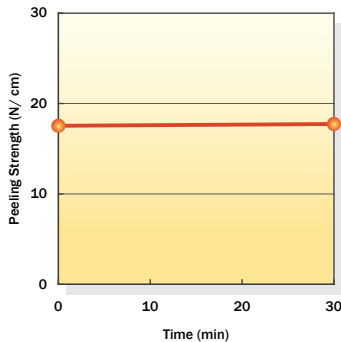

圖6. 高溫儲存環境測試150°C

Figure 7. Peeling strength after aging test at 150°C

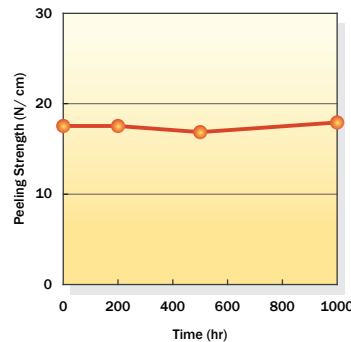

圖7. 冷熱衝擊測試
-50°C/ 30min ~ 150°C/30min

Figure 8. Peeling strength after thermal shock test during -50°C/30min ~ 150°C/30min

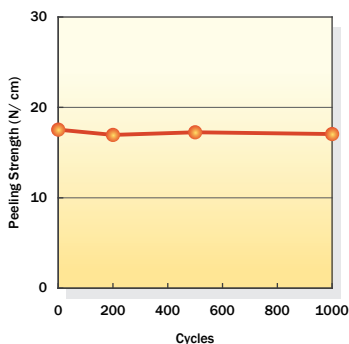

圖8. 高溫高濕環境測試
85°C/ 85%RH

Figure 9. Peeling strength after aging test at 85°C/ 85%RH

高導熱雙面板 / Thermal Conductive Core

■ 產品簡介 / Product Description

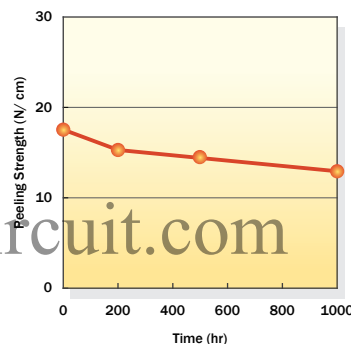
高導熱雙面板(TCC)是具有良好的導熱性以及可靠度的產品。其為導熱膠雙面貼覆導電用銅箔層之三層結構，是適用於生產一般之多層板及薄型電路板所需要之基材。

Thermal Conductive Core (TCC) is a kind of copper clad laminate, which provides the advantages of high thermal conductivity and reliability. TCC is good for general requirement of multilayer or thinner shape printed circuit board. TCC is a sandwich structure, which includes layers of upper copper foil, thermal conductive dielectric layer, and lower copper foil.



圖10. TCC產品結構圖/ Figure 10. Substrate structure of Thermal Conductive Core

表3. 產品規格/ Table 5. Standard specification of TCC

項目/Item	材質/Material	規格/Specification	備註/Note
基板尺寸/Panel Size		610x510mm	
導熱絕緣層/Dielectric Layer	環氧樹脂/Epoxy resin 陶瓷填充物/Ceramic filler	80, 100, 150 μ m	
銅箔/Cu Foil	電解銅箔/Copper	1 oz	General Circuit
		2 oz	High Current Circuit
		3~6 oz	Ultra High Current Circuit

若有任何特殊規格需求，請與我們聯繫 / If there is any specific inquiry other than the standard specification, please contact us.

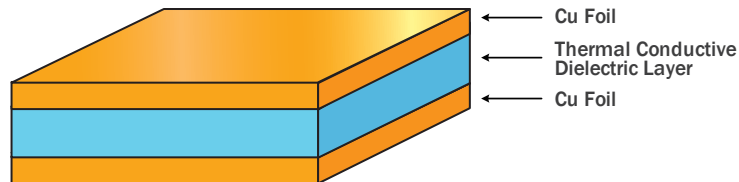
■ 產品料號定義 / Part Number Definition

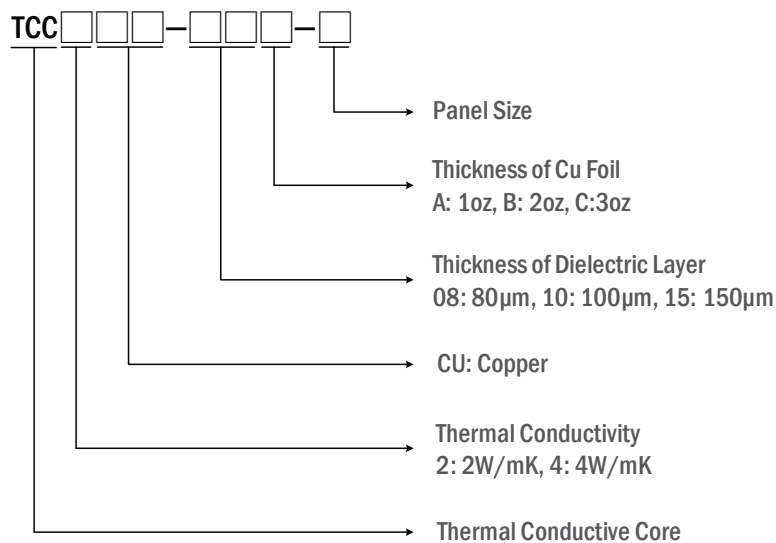

高導熱膠片 / Thermal Conductive Prepreg

■ 產品簡介 / Product Description

高導熱膠片(TCP)具有極佳的導熱性以及可靠度，可充分滿足各種單層板以及多層板之需求。

Thermal Conductive Prepreg (TCP) provides the advantages of high thermal conductivity and reliability. This semi-finished material is good for single and multilayer thermal conductive printed circuit board application. TCP is a sandwich structure, which includes layers of upper release film, prepreg, and lower release film.



圖11. 高導熱膠片結構圖/ Figure 11. Substrate structure of TCP

表4. 高導熱膠片規格表/ Table 6. Standard specification of TCP

項目/Item	材質/Material	規格/Specification	備註/Note
離型膜厚度/Release Film Thickness	PET	75 μ m	藍/Blue (TCP-2) 黃/Yellow (TCP-4) 紅/Red (TCP-8)
膠片尺寸/Prepreg Size	環氧樹脂/Epoxy resin 陶瓷填充物/Ceramic filler	520mm x 630mm (片材/Panel) 520mm x 50M (捲料/Roll)	
膠片厚度/Prepreg Thickness	環氧樹脂/Epoxy resin 陶瓷填充物/Ceramic filler	80, 100, 150 μ m	

若有任何特殊規格需求，請與我們聯繫 / If there is any specific inquiry other than the standard specification, please contact us.

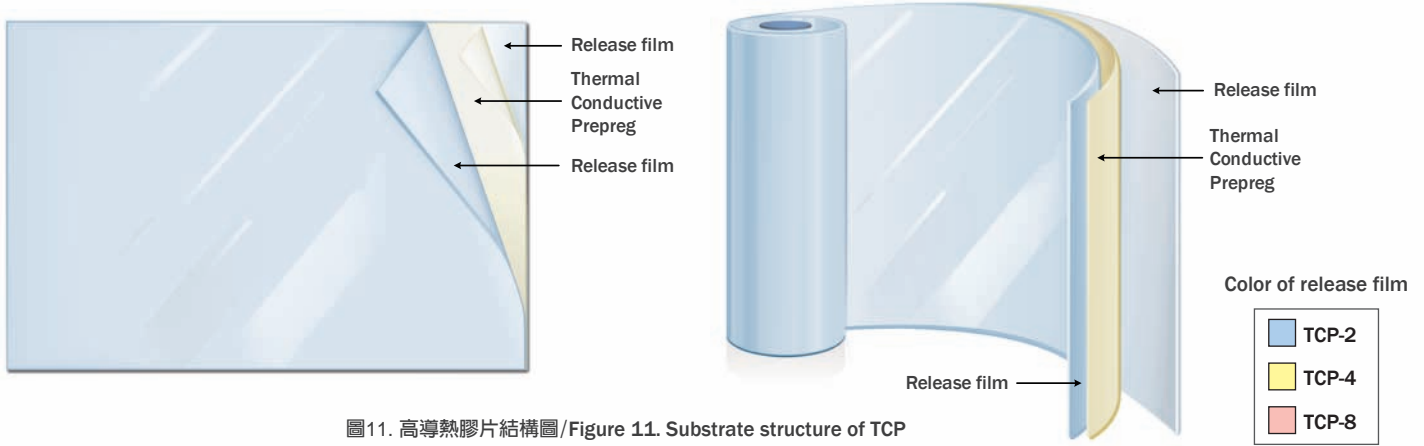
■ 產品料號定義 / Part Number Definition

片材包裝/Panel Package

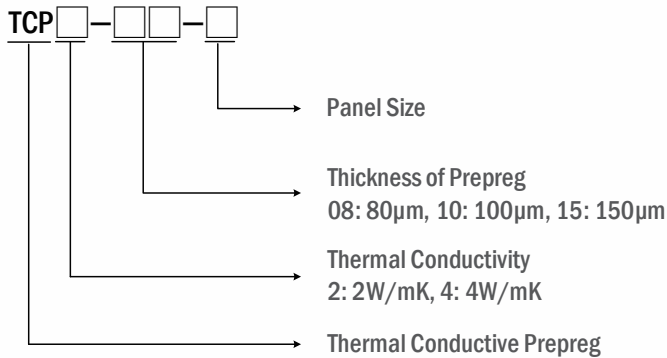

捲料包裝/Roll Package

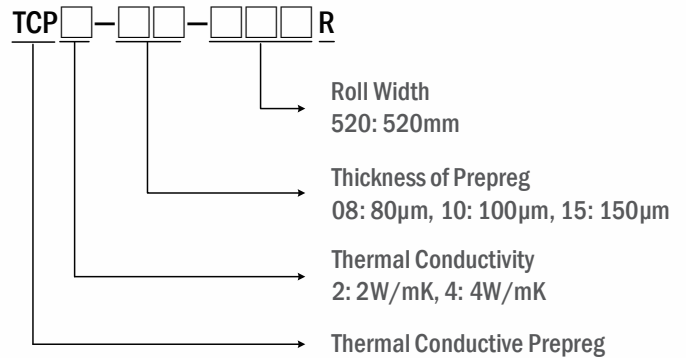

■ 注意事項 / Note

- 儲存環境：保持真空包裝或良好密封狀態下可於35°C/ 65%RH環境下保存3個月或於20°C/ 55%RH環境下保存6個月 (濕氣會造成壓合良率下降)
- 裁切：可使用刀片、裁切機或沖切設備
- 膠片於外力衝擊下可能產生裂痕，於運送及取放作業時請小心處理
- Storage: 35°C/ 65%RH for 3 months or 20°C/ 55%RH for 6 months with vacuum package. (Humidity may reduce the yield of vacuum lamination process.)
- Cutting: Knife, shear, or punch
- Handling: Prepreg is fragile with impact. Please handle with care.

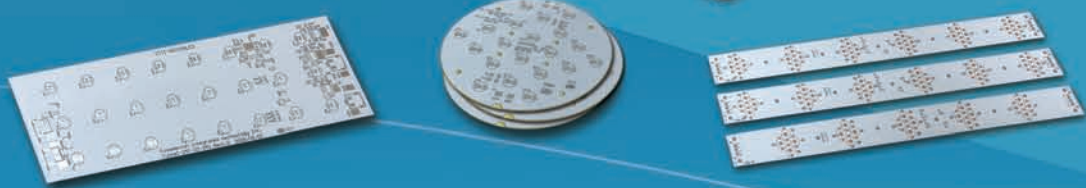

<http://www.pttc.com.tw>

WE MAKE IT BETTER AND MORE RELIABLE!

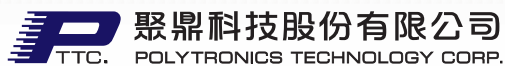

Taiwan, Greater China, & Oversea Sales Office

新竹市科學工業園區工業東四路24-1號
No. 24-1 Industry E. Rd. IV,
Hsinchu Science Park, Hsinchu 300, Taiwan
TEL: +886 (3) 564-3931
FAX: +886 (3) 564-4624
E-mail: tcbsales@pttc.com.tw



China Sales Office

江苏省昆山市汉浦路998号
998 Han-Pu Rd., Hi-Tech Industrial Park,
Kunshan, Jiangsu 215316, China
TEL: +86 (512) 8616-2818
FAX: +86 (512) 8616-2816
E-mail: salescn@everfuse.com